



## Worldwide distributor of high quality router bits

**Infinity Tools is a worldwide distributor of high quality router bits.**

**Infinity tools UK provides the professional as well as the weekend woodworker a direct source of high quality router cutters, accessories and other woodcutting tools. By purchasing from this website you will obtain high quality products at competitive prices that are hard to beat. There is a greater range on our website – website prices are the up to date ones.**

**When it comes to high performance router bits we feel there is no equal.  
Save Money. All of our prices include VAT**

## Contents

Type of Bit	Page No.	Type of Bit	Page No.
17 <sup>th</sup> Century Profile Bits	15	Lock Mitre Bits	5
Architectural Bits	15	Mortice & Tenon Bits	11
Bowl & Tray Bits	7	Moulding Bits	14
Box Joint Bits	6	Ogee Bits	11
Bull Nose Bits	13	Ovolo Bits	7
Chamfer Bits	13	Profile Bits	7
Colonial Period Profile Bits	15	Pilot Roundover Bits	12
Cove Bits	14	Raised Panel Bits	4
Dado Bits	7	Rebate Bits	8
Door making Bits	3	Reverse Glue Joint Bits	5
Dovetail Bits	9	Roundnose Bits	12
Drawer locking Bits	5	Roundover Bits	12
Edge Beading Bits	13	Sign Making Bits	10
Edge Forming Bits	13	Slot Cutting Bits	11
Finger Joint Bits	6	Spiral Bit	2
Finger Pull Bits	6	Straight Bits	1
Flush Trim Bits	8	Table Edge Bits	14
Flute & Bead Bits	5	Tongue & Groove Bits	6
Grooving	7	Top Bearing Bits	2
Joinery Bits	4	Window Sash Bits	5



## Essential Six Router Bits.



Comprises:

1/4" shank	38-190	1/8" Roundover Bit
1/2" shank	38-754	1/4" Roundover Bit
1/2" shank	00-555	Rabate Combination Set*
1/2" shank	36-920	45° Chamfer Bit
1/2" shank	11-628	Straight Bit
1/2" shank	06-627	Flush Trim Bit

\* set contains 7 bearings: 7/8", 1/2, 5/8", 3/4", 7/8", 1 1/8", 1 3/8"

**13% off individual prices £144**

# Straight Bits

Designed for superior performance, Infinity straight bits cut smooth and do not leave burn marks like you find on inferior quality bits.



Premium quality solid carbide straight bits for fast and efficient production. Ideal for plywood.

## 1/4 inch shank Carbide Tipped

Part no.	Cut Dia.	Cut ht.	LOA	Price inc VAT
11-081	5/16"	1"	2 3/4"	£14.99
11-096	3/8 "	1"	2 1/2"	£14.99
11-143	3/8"	1 1/4"	3"	
11-123	31/64"	1"	2 1/4"	£15.78
11-127	1/2 "	3/4 "	2 1/4"	£14.99
12-127	1/2 "	1"	2 3/4"	£16.57
11-142	9/16"	9/16"	2 1/4"	£13.40
11-158	5/8"	3/4"	2 1/4"	£15.78
11-182	23/32"	1"	2 1/4"	£17.36
11-191	3/4 "	3/4"	2 1/4"	£14.20
11-254	1"	3/4 "	2 1/2"	£18.17

## 1/2 inch shank Carbide Tipped

Part no.	Cut Dia.	Cut ht.	LOA	Price inc VAT
11-595	3/8"	1"	2 5/8"	£14.20
12-595	3/8"	1 1/4"	2 7/8"	£16.57
12-611	7/16"	1 1/4"	3 1/4"	£18.96
11-623	31/64"	1"	2 1/4"	£15.78
11-627	1/2"	1"	2 5/8"	£15.78
11-628	1/2"	1"	3 1/4"	£16.57
12-627	1/2"	1 1/2"	3 1/8"	£18.96
12-669	1/2"	2"	4 1/4"	£23.00
11-660	5/8"	1"	2 1/2"	£17.36
11-682	23/32"	1"	2 1/4"	£17.36
11-690	3/4"	1"	2 1/2"	£17.36
12-690	3/4"	1 1/2"	3 1/4"	£20.54
11-754	1"	1 1/4"	3"	£22.92
12-671	3/4"	2"	3 3/4"	£26.96

## 1/4 inch shank Solid Carbide

Part no.	Cut Dia.	Cut ht.	LOA	Price inc VAT
11-132	1/16"	3/16"	2"	£22.13
12-032	1/8 "	1/2"	2"	£17.36
11-040	5/32"	5/8"	2"	£18.17
11-047	3/16"	3/4"	2"	£18.17
12-060	15/64"	3/4"	2 3/8"	£17.36
11-064	1/4 "	7/8"	2 1/2"	£18.17
12-064	1/4 "	1"	2 1/2 "	£18.17

## 1/4 inch shank Solid Carbide Ply Cutter

Part no.	Ply	Cut Dia.	Cut ht.	LOA	Price inc VAT
12-060	1/4"	15/64"	3/4"	2 3/8"	£17.36
11-123	1/2"	31/64"	1"	2 1/4"	£15.78
11-182	3/4"	23/32"	1"	2 1/4"	£17.36

## 1/2 inch shank Solid Carbide Ply Cut

Part no.	Ply	Cut Dia.	Cut ht.	LOA	Price inc VAT
11-560	1/4 "	15/64"	3/4"	2 3/8"	£19.75
11-623	1/2"	31/64"	1"	2 1/4"	£15.78
11-682	3/4"	23/32"	1"	2 1/4"	£17.36

## 1/2 inch shank Solid Carbide

Part no.	Cut Dia.	Cut ht.	LOA	Price inc VAT
11-560	15/64"	3/4 "	2 3/8"	£19.75
11-564	1/4 "	3/4 "	2 3/8"	£18.96

www.InfinityTools.co.uk 0560 115 0224

# Top Bearing Pattern Bits

## 1/4 inch shank

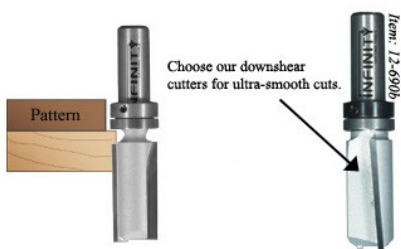

Part no.	Cut Dia.	Cut ht.	Bearing dia.	Price inc VAT
11-081B	5/16"	1"	1/2"	£20.51
11-127B	1/2"	3/4"	1/2"	£20.51
11-142B	9/16"	9/16"	5/8"	£18.92
11-158B	5/8"	3/4"	5/8"	£21.30
11-159B	5/8"	1/2"	5/8"	£18.96
12-127B	1/2"	1"	1/2"	£22.09

## Top Bearing Kits (no bit)

Part no.	Inside dia.	Outside dia.	Price inc VAT
PBK-109	1/4"	1/2"	£5.88
PBK-111	1/4"	5/8"	£5.88
PBK-110	1/4"	3/4"	£5.88
PBK-104	1/2"	3/4"	£5.88
PBK-107	1/2"	1 1/8"	£5.88
PBK-112	1/2"	1 1/4"	£5.88
PBK-113	1/2"	1 1/2"	£5.88
PBK-114	1/2"	1"	£5.88

## 1/2 inch shank

Part no.	Cut Dia.	Cut ht.	Bearing dia.	Price inc VAT
11-690B	3/4"	1"	3/4"	£22.88
12-690B	3/4"	1 1/2"	3/4"	£26.06
12-671B	3/4"	2"	3/4"	£32.48

# Solid Carbide Spiral Bits



**Upcut** spirals clear chips from the kerf and allow faster feed rates than downcut spirals.

**Downcut** spirals push wood fibres down for a cleaner top surface.

## Up Cut Spiral

### 1/4 inch shank

Part No.	Dia.	Cut ht.	LOA	Price inc VAT
85-101	1/8"	1/2"	2"	£18.17
85-103	5/32"	5/8"	2"	£18.17
85-105	3/16"	3/4"	2 1/2"	£18.17
85-109	1/4"	7/8"	2 1/2"	£18.96
85-113	1/4"	1"	2 1/2"	£18.96

## Down Cut Spiral

### 1/4 inch shank

Part No.	Dia.	Cut ht.	LOA	Price inc VAT
85-102	1/8"	1/2"	2"	£18.17
85-104	5/32"	5/8"	2"	£18.17
85-106	3/16"	3/4"	2 1/2"	£18.17
85-110	1/4"	7/8"	2 1/2"	£18.96
85-114	1/4"	1"	2 1/2"	£18.96

### 1/2 inch shank

Part No.	Dia.	Cut ht.	LOA	Price inc VAT
85-905	5/16"	1 1/8"	3"	£54.44
85-907	3/8"	1 1/4"	3"	£55.44
85-911	1/2"	1 1/4"	3"	£53.86
85-913	1/2"	1 5/8"	3 1/2"	£58.61
85-915	1/2"	2 1/8"	4"	£65.75

### 1/2 inch shank

Part No.	Dia.	Cut ht.	LOA	Price inc VAT
85-906	5/16"	1 1/8"	3"	£54.44
85-908	3/8"	1 1/4"	3"	£55.44
85-912	1/2"	1 1/4"	3"	£53.86
85-914	1/2"	1 5/8"	3 1/2"	£58.61
85-916	1/2"	2 1/8"	4"	£65.75

## Up And Down Cut Spiral

### 1/2 inch shank

Part No.	Dia.	Cut ht.	LOA	Price inc VAT
85-919	1/2"	1 5/8"	4"	£103.03

# Door Making



These bits cut a quick rabbet in the back of 3/4" (19 mm) thick door panels allowing you to keep the face of the panel flush with the face of the rails & stiles by producing a 1/4" (6.3 mm) tongue.

There is an option for a bevel cut or a radius cut **All 1/2" shanks**

## Three wing Back Cutter bits

Part No.	Profile	Cut dia	Cut ht.	LOA	Price inc VAT
09-501	Radius	1 7/8"	1/4"	2 3/8"	£31.64
09-502	Bevel	1 7/8"	1/4"	2 3/8"	£31.64
23-Ply	Ply		15/64"		£18.17

## Glass Panel Door bits

Part No.	Cut dia	Cut ht.	LOA	Price inc VAT
91-523	1 3/4"	7/8"	3"	£55.44

## Miniature Doormaking System

Part No.		Cut dia	Cut ht.	Price inc VAT
91-524	Rail & Stile set	1 1/8"	1/2"	£86.45
90-505	Raised panel bit	1 3/4"	7/16"	£52.27

## Entry & Passage Door Set

Part No.	Cut dia	Cut ht.	Profile Width	LOA	Price inc VAT
91-522	1 3/4"	1 7/8"	1/2"	3 3/4"	£151.40

## One Piece Ogee Rail & Stile bit

Part No.	Cut dia	Cut ht.	LOA	Width	Price inc VAT
91-521	1 3/4"	1 3/8"	3 1/2"	7/16"	£95.10

# Door Making - Raised Panel Bits

Choose from six popular raised panel profiles for your cabinet doors. Each Infinity raised panel bit features thick micro-grain carbide tips engineered with aggressive shear angles for ultra-smooth cuts, even against the grain.

## Two wing horizontal 1/2" shank

Part No.	Profile	Bit Dia.	Width	Height	Price inc VAT
90-501	Ogee	3 1/8"	1 3/8"	9/16"	£67.33
90-502	Standard	3 1/8"	1 3/8"	9/16"	£67.33
90-503	Bevel & radius	3 1/8"	1 3/8"	9/16"	£67.33
90-504	Cove	3 1/8"	1 3/8"	9/16"	£67.33
90-505	Mini Ogee	1-3/4"	5/8"	7/16"	£43.56
90-506	Shaker	2 3/4"	1 1/8"	9/16"	£67.33

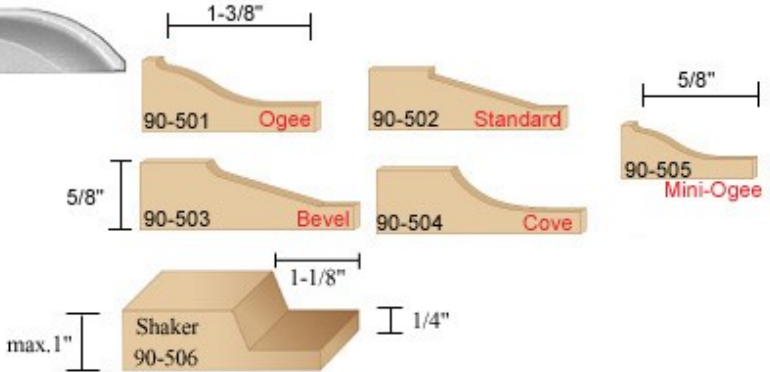

Mill beautiful raised panel doors and drawer faces with economy and ease! Use a sturdy fence set 90-degrees to the router table and a minimum 2-1/4-HP router. These vertical panel cutters offer an attractive 1-1/2" reveal on your panel front.

## Two wing vertical 1/2" shank

Part No.	Profile	Cut Dia.	Cut ht.	Cut depth	Price inc VAT
90-601	Ogee	1 1/2"	1 1/2"	3/8"	£52.27
90-602	Standard	1 1/2"	1 1/2"	3/8"	£52.27
90-604	Cove	1 1/2"	1 1/2"	3/8"	£52.27

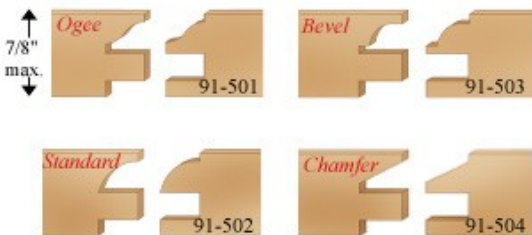

Matched male and female sets produce precise joints with speed and accuracy. They are designed to be used with rail and stile stock from 3/4" to 7/8"

## Rail & Stile Cutter 1/2" shank

Part No.	Profile	Cut Dia.	Profile Width	Price inc VAT
91-501	Ogee	1 3/4"	7/16"	£110.16
91-502	Standard	1 3/4"	7/16"	£110.16
91-503	Bevel & radius	1 3/4"	7/16"	£110.16
91-504	Chamfer	1 3/4"	7/16"	£110.16
91-505	Shaker	1 3/4"	7/16"	£110.16

# 1/2" Shank Joinery Bits



Strong well cut joints are the secret of well constructed drawers. Cut them with speed & efficiency



Use with stock up to 1-1/4" thick.

Fast accurate glue ups are the trademark of this bit

## Drawer Locking Bits

Part No.	Cut dia.	Cut ht.	LOA	Price inc. VAT
55-512	1 3/4"	1/2"	2 1/16"	£57.02

## Reverse Glue Joint bit (inc set up block)

Part No.	Cut dia.	Cut ht.	LOA	Price inc. VAT
55-501	1 3/4"	1 1/4"	2 3/4"	£57.02

## Lock Mitre & small Lock Mitre (including set up block)

Part No.	Cut dia.	Cut ht.	LOA	Cutter angle	Price inc. VAT
55-503	2 3/4"	1 3/16"	3"	45	£75.26
55-502	2"	3/4"	2 3/8"	45	£67.33

Cut the strongest mitre joints

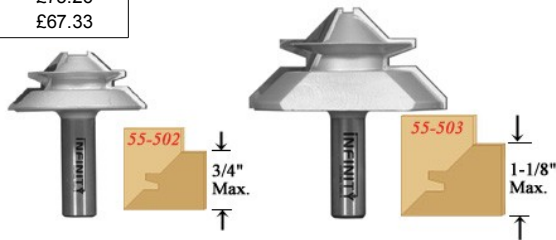
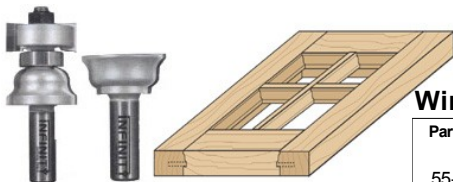

## Window Sash Set

Part No.	Cut dia.	Cut ht.	LOA	Price inc. VAT
55-801				£113.34
Large bit	1 1/4"	1 1/2"	3 7/16"	
Small bit	1 1/4"	11/16"	2 3/16"	

This set is designed to mill sash parts that offer elegance and strength. It also produces perfectly matched rail and stile parts for custom built French Windows. They are designed for 1-3/8 inch (35 mm) stock. The set comprises two bits and instructions.

## Flute & Bead Set

Part No.	Cut dia.	Cut ht. 1	Cut ht. 2	LOA	Price inc. VAT
55-701	1 1/2"	7/16"	1/4"	1 7/8"	£77.65

Build unique curved planters, canoes, hot tubs etc.

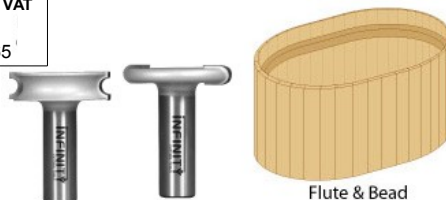

# 1/2" Shank Joinery Bits

Box joints are beautiful and strong and are easy with this bit.

Bit includes five 5/32" slot cutters. Use in stock up to 1-9/16" high.

Works with stock up to 1/2" thick.



## Box Joint Bit

Part No.	Cut dia.	Cut ht.	LOA	Price inc. VAT
61-501	1 7/8"	1 13/32"	3 3/4"	£93.50



This set produces fast tongue and groove cuts without the hassle of changing set-ups for each cut.



For use with stock from 5/8" to 1-3/8" thick.



## Tongue & Groove Set

Part No.	Cut dia.	Cut ht.	Price inc. VAT
61-502			£69.72
	Large bit	1 3/4"	3/4"
	Small bit	1 3/4"	1/4"

Perfect finger joints in stock between 5/8" & 1-3/8"

## Finger Joint Bit

Part No.	Cut dia.	Cut ht.	LOA	Price inc. VAT
61-500	1 7/8"	1 3/16"	3 3/4"	£118.88

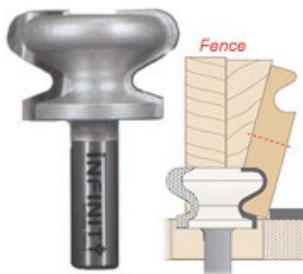

The Finger Pull bit also puts an attractive edge on doors and drawer fronts. Be sure to use the router table and fence.

Continuous draw pulls are ideal for lighter shades of laminate.

## Finger Pull bits

Part No.	Cut dia.	Cut ht.	LOA	Price inc. VAT
55-601	1 7/8"	1 1/8"	2 11/16"	£57.02

More details can be seen on our website

[www.InfinityTools.co.uk](http://www.InfinityTools.co.uk) 0560 115 0224

# Grooving & Profile

This bit is perfect for routing bowls, trays, boxes and other speciality items.

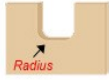

Bit shown with optional pattern bearing kit.

The Queen Anne bit mills the oval shape found on fine furniture.



## Bowl & Tray Bits 1/4 inch shank

Part no.	Cut Dia.	Cut ht.	Cut Radius	Bearing dia.	Price inc. VAT
51-001	7/16"	1/2"	1/8"		£27.68
51-002	3/4"	5/8"	1/4"		£30.85
51-002B	3/4"	5/8"	1/4"	3/4"	£36.37

## Queen Anne bit 1/2 inch shank

Part no.	Cut Dia.	Cut ht.	Price inc. VAT
10-500	1"	3/4"	£27.68

## 1/2 inch shank

Part no.	Cut Dia.	Cut ht.	Cut Radius	Bearing dia.	Price inc. VAT
51-501	3/4"	5/8"	1/4"		£30.85
51-501B	3/4"	5/8"	1/4"	3/4"	£36.37
51-502	1 1/4"	5/8"	1/4"		£31.64
51-502B	1 1/4"	5/8"	1/4"	1 1/4"	£37.16



Step 1

Table

This Thumb Nail bit will turn siple 3/4" x 3/4" stock into log home kits and much more.



Step 2

Table

## Thumbnail Bit 1/2 inch shank

Part no.	Cut Dia.	Cut ht.	LOA	Price inc. VAT
03-500	7/8"	7/8"	2 3/8"	£29.27

## Dado & Planer bits

### 1/4 inch shank

Part no.	Cut Dia.	Cut ht.	LOA	Bearing dia.	Price inc. VAT
52-001	3/4"	3/8"	2 1/4"		£18.17
52-001B	3/4"	3/8"	2 1/4"	3/4"	£23.69

### 1/2 inch shank

Part no.	Cut Dia.	Cut ht.	LOA	Bearing dia.	Price inc. VAT
52-501	3/4"	3/8"	2 1/2"		£19.75
52-501B	3/4"	3/8"	2 1/2"	3/4"	£25.27
52-502	1"	3/8"	2 1/2"		£20.54
52-503	1 1/4"	5/8"	2 3/4"		£24.50
52-503B	1 1/4"	5/8"	2 3/4"	1 1/4"	£30.02
52-504	1 1/2"	5/8"	2 3/4"		£24.50
52-504B	1 1/2"	5/8"	2 3/4"	1 1/2"	£30.02



Bit shown with optional pattern bearing kit.

## Ovolo Bits Each Ovolo Bit Cuts 1/2 inch shank Multiple Profiles!



Bit shown with optional pattern bearing kit.

Part no.	Cut Dia.	Cut ht.	Cut Radius	Bearing dia.	Price inc. VAT
27-560	1"	1/2"	1/4"		£23.71
27-560B	1"	1/2"	1/4"	1"	£29.23
27-595	1 1/4"	9/16"	3/8"		£27.68
27-595B	1 1/4"	9/16"	3/8"	1 1/4"	£33.20
27-627	1 1/2"	3/4"	1/2"		£31.64
27-627B	1 1/2"	3/4"	1/2"	1 1/2"	£37.16

# Rabbet & Flush Trim Bits

The ideal cabinet makers router bit. It trims the face frames flush with the cabinet sides. The V-shaped cutter adds a groove along the joint of the frame and side for decorative effect and to help hide the seam. Trims face frames up to 1" (25 mm) thick.

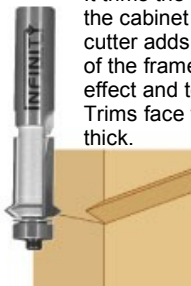

## Flush & V-Groove bits

### 1/4" Shank

Order no.	Cut Dia.1	Cut Dia.2	Cut ht.	LOA	Price inc VAT
53-001	5/8"	3/4"	1"	2 5/8"	£24.50

### 1/2" Shank

Order no.	Cut Dia.1	Cut Dia.2	Cut ht.	LOA	Price inc. VAT
53-501	5/8"	3/4"	1"	2 5/8"	£24.50

## Flush Trim bits, down shear

### 1/4" Shank

Order no.	Cut Dia.	Cut ht.	LOA	Price inc VAT
06-095	3/8"	1"	2 5/8"	£16.57
06-127	1/2"	1"	2 5/8"	£16.57

### 1/2" Shank

Order no.	Cut Dia.	Cut ht.	LOA	Price inc VAT
06-690	3/4"	2"	4"	£31.64
06-691	3/4"	1"	3"	£29.27
06-627	1/2"	1"	2 5/8"	£16.57
06-629	1/2"	1 1/2"	3 5/8"	£18.96
06-630	1/2"	2"	4"	£31.64

## Multi-Bearing Pattern set

### 1/2" Shank

Order no.	Cut Dia.	Cut ht.	LOA	Price inc VAT
06-630	1/2"	2"	4"	£31.64
35-851	1 1/2"	2"	4"	£41.95
RB-156	Bearing kit	5/8"; 7/8"; 1"; 1 1/4"; 1 3/8"; & 1 1/2"	bearings	£31.64

## Spiral Flush Trim 1/2" Shank

Order no.	Cut Dia.	Cut ht.	LOA	Price inc VAT
85-920 Down Cut	1/2"	1-1/4"	3-1/2"	£67.44
85-921 Up Cut	1/2"	1-1/4"	3-1/2"	£67.44

### 1/4" Shank

Order no.	Cut Dia.	Cut ht.	LOA	Price inc VAT
35-350	1 3/8"	1/2"	2 3/8"	£27.68

### 1/2" Shank

Order no.	Cut Dia.	Cut ht.	LOA	Price inc VAT
35-850	1 3/8"	1/2"	2 3/8"	£27.68
35-855	1 3/8"	1"	2 7/8"	£35.62
RB-155	Bearing kit	1/2"; 5/8"; 3/4"; 7/8"; 1 1/8" & 1 3/8"	bearings	£31.64

## 7pc. Rabbet Combo Set

Order no.	Cut Dia.	Cut ht.	LOA	Price inc VAT
00-555	35-850 & RB-155			£54.60
00-556	35-855 & RB-155			£67.26

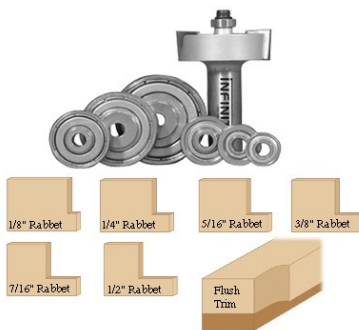
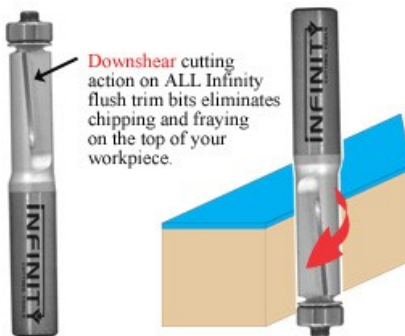

# Dovetail Bits

## 1/4" Shank

Part no.	Cut Dia.	Cut ht.	LOA	Angle	Price inc. VAT
18-064	1/4"	5/16"	2"	7.5	£20.54
18-065	1/4"	1/4"	2 1/2"	8	£20.54
18-081	5/16"	3/8"	2 1/16"	8	£20.54
18-080	5/16"	3/8"	2 1/16"	9	£19.75
18-096	3/8"	3/8"	2 1/16"	9	£17.36
18-097	3/8"	1/2"	2 3/8"	8	£20.54
18-134	7/16"	5/8"	2 3/8"	8	£18.17
18-131	1/2"	5/8"	2 3/8"	10	£19.75
18-132	1/2"	13/32"	2 3/8"	18	£19.75
18-128	1/2"	1/2"	2 1/16"	14	£17.36
18-130	1/2"	1/2"	2 7/16"	14	£17.36
18-129	1/2"	13/16"	2 3/4"	8	£18.17
18-158	5/8"	7/8"	2 3/8"	7	£25.30
18-190	3/4"	7/8"	2 3/8"	7	£26.09
18-191	3/4"	7/8"	2 3/8"	14	£26.89

Well fit dovetail joints are the mark of a true craftsman!

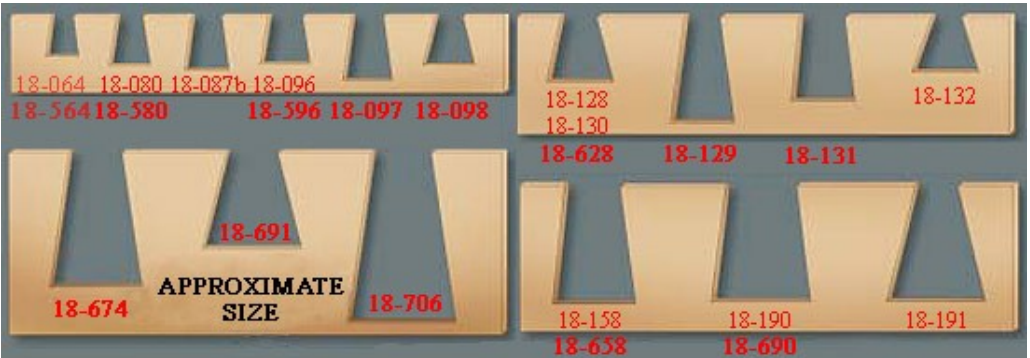

## 1/2" Shank

Part no.	Cut Dia.	Cut ht.	LOA	Angle	Price inc. VAT
18-564	1/4"	5/16"	2"	7.5	£19.75
18-580	5/16"	3/8"	2 1/2"	9	£20.54
18-596	3/8"	3/8"	2 1/2"	9	£20.54
18-628	1/2"	1/2"	2 1/2"	14	£19.75
18-658	5/8"	7/8"	2 5/8"	7	£25.30
18-674	11/16"	1"	3 1/16"	8	£27.68
18-690	3/4"	7/8"	2 5/8"	7	£26.09
18-691	3/4"	3/4"	3 1/16"	14	£26.09
18-706	13/16"	1 1/4"	3 5/16"	8	£27.68

More details can be seen on our website

[www.InfinityTools.co.uk](http://www.InfinityTools.co.uk) 0560 115 0224

# Sign Making



58-500

58-502

58-504

## Point Cutting Bits

### 1/2" Shank

Part no.	Cut Dia.	Cut ht.	Bearing dia.	Cutter angle	Price inc. VAT
58-500	1 1/8"	1 1/4"	N/A	20	£25.30
58-500B	1 1/8"	1 1/4"	1 1/8"	20	£30.82

## Radius Grooving Bits

### 1/2" Shank

Part no.	Cut Dia.	Cut ht.	Cutter radius	Bearing dia.	Price inc. VAT
58-502	1 1/8"	3/4"	1/2"	n/a	£23.71
58-502B	1 1/8"	3/4"	1/2"	1 1/8"	£29.23
58-504	3/4"	5/8"	3/8"	n/a	£21.34
58-504B	3/4"	5/8"	3/8"	3/4"	£26.86



49-501



58-001



15-127

## Lettering Bits

### 1/2" Shank

Part no.	Cut Dia.	Cut ht.	Bearing dia.	Cutter angle	Price inc. VAT
49-501	1 1/8"	3/4"	N/A	60	£26.09
49-501B	1 1/8"	3/4"	1 1/8"	60	31.97

## Laser Point Bits

### 1/4" Shank Solid carbide

Part no.	Cut Dia.	Cut ht.	Cutter angle	Price inc. VAT
58-001	5/8"	7/16"	60	£27.68

## V-Grooving Bits

### 1/4" Shank

Part no.	Cut Dia.	Cut ht.	Bearing dia.	Cutter angle	Price inc. VAT
15-127	1/2"	1/2"		90	£19.75
15-127B	1/2"	1/2"	1/2"	90	£25.63



*Infinity V-Groove bits cut clean sharp sign lettering or decorative veins.*



**Floating Letter**

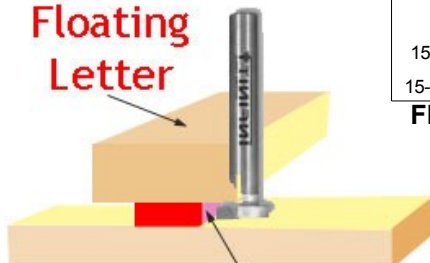

**Under cut**

### 1/2" Shank

Part no.	Cut Dia.	Cut ht.	Bearing dia.	Cutter angle	Price inc. VAT
15-690	3/4"	5/8"		90	£23.13
15-690B	3/4"	5/8"	3/4"	90	£29.00

## Floating Lettering Bit

Under cut the letters to make them appear to float.

### 1/4" Shank

Part no.	Cut Dia.	Cut ht.	Price inc. VAT
05-000	1/2"	1/4"	£15.78

# Three Wing Slot Cutters

Our three-wing slot cutters allow you to cut rabbets or grooves, slot for biscuits, mill tongue and groove stock or rout grooves for T-moulding.

Note: Purchase arbour separately.



All Infinity slot cutters feature 3-wing micrograin carbide tips and anti-kickback design for long life and extra smooth cuts.

## Slot Cutter Sets

### 1/2" Shank

Part no.	Description	Price inc. VAT
61-503	Variable groove cutter, 1/8" to 11/16" Includes 1/8", 5/32", 3/16" & 1/4" cutters	£66.54

## Slot Cutter Arbours & Bearings

Part no.	Description	Price inc. VAT
24-064	1/4" Shank with Bearing 1/2" cut depth	£12.94
24-127	1/2" Shank with Bearing 1/2" cut depth	£12.94
BR-116	Bearing only 3/8" cut depth	£7.56
BR-117	Bearing only 5/16" cut depth	£7.56
BR-118	Bearing only 1/4" cut depth	£7.56

### 1/4" Shank

Part no.	Cut Dia.	Cut ht.	LOA	Bearing dia.	Price inc. VAT
01-128	1/2"	5/16"	1 7/8"		£12.61
01-127	1/2"	3/4"	2 1/8"		£12.61
01-127B	1/2"	3/4"	2 1/8"	1/2"	£18.13
01-190	3/4"	3/4"	2 1/8"		£14.99
01-190B	3/4"	3/4"	2 1/8"	3/4"	£20.51

### 1/2" Shank

Part no.	Cut Dia.	Cut ht.	LOA	Bearing dia.	Price inc. VAT
01-627	1/2"	3/4"	2 3/8"		£14.99
01-690	3/4"	3/4"	2 1/4"		£21.34
01-690B	3/4"	3/4"	2 1/4"	3/4"	£26.86
01-817	1 1/4"	1/2"	2 1/8"		£19.75
01-817B	1 1/4"	1/2"	2 1/8"	1 1/4"	£25.27
01-818	1 1/4"	15/64"	2 3/8"		£21.34
01-818B	1 1/4"	15/64"	2 3/8"	1 1/4"	£26.86

## Keyhole Bit

	Part no.	Large dia.	Small dia.	Cut ht.	LOA	Price inc. VAT
1/4" Shank	50-001	3/8"	3/16"	7/16"	1 3/4"	£20.54
1/2" Shank	50-501	3/8"	3/16"	7/16"	1 3/4"	£20.54

### 1/4" Arbour

Part no.	Cut ht.	Common Application	Price inc. VAT
23-180A	1/8"	Slot for draw bottoms	£18.17
23-532A	5/32"	Slot for biscuits	£18.17
23-316A	3/16"	Slot for weather stripping	£18.17
23-1564A	15/64	Slot for 6mm ply wood	£18.17
23-140A	1/4"	Tongue & groove joints	£18.17

### 1/2" Arbour

Part no.	Cut ht.	Common Application	Price inc. VAT
23-180B	1/8"	Slot for draw bottoms	£18.17
23-532B	5/32"	Slot for biscuits	£18.17
23-316B	3/16"	Slot for weather stripping	£18.17
23-1564B	15/64	Slot for 6mm ply wood	£18.17
23-140B	1/4"	Tongue & groove joints	£18.17

Set includes one 1/8", 5/32", 3/16" and 1/4" kerf slot cutters.



Vary the spacing and combination of the cutters to cut slots of between 1/8" and 11/16" wide



# Mortise & Tenon

These Mortise bits feature downshear cutting action for super clean cuts!



The small diameter of this bit cuts a 3/16" wide slot while the larger diam. cuts a wider slot beneath the surface.



# Ogee Bits

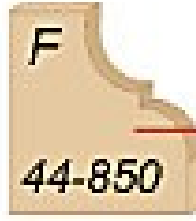

## 1/4" Shank

Part no.	Description	Cut Dia.	Cut ht.	Cutter radius	Price inc. VAT
40-350	Roman	1 1/2"	3/4"	1/4"	£30.06

Profiles to suit most decorative needs.

## 1/2" Shank

Part no.	Description	Cut Dia.	Cut ht.	Cutter radius	Price inc. VAT
40-770	Roman	1"	1/2"	5/32"	£27.68
40-850	Roman	1 1/2"	3/4"	1/4"	£30.06
41-785	Double Roman	1 3/16"	1/2"	5/32"	£30.85
41-880	Double Roman	1 9/16"	3/4"	1/4"	£32.44
44-787	Classical	1 1/8"	1/2"	5/32"	£30.85
44-850	Classical	1 3/8"	11/16"	1/4"	£34.02
46-825	With fillet	1 9/32"	1/2"	3/16" & 9/64"	£31.64
59-564	Inverted	1 1/2"	3/4"	1/4"	£35.62



## Plunge Ogee Bits

### 1/2" Shank



Part no.	Cut Dia.	Cut ht.	LOA	Cutter radius	Price inc. VAT	Bearing Dia.
48-590	3/4"	1/2"	2	5/32"	£23.71	
48-590B	3/4"	1/2"	2	5/32"	£29.59	3/4" PBK-104

# Roundover & Roundnose Bits

## Roundover Bits

### 1/4" Shank

Part no.	Cut Dia.	Cut ht.	Cut Radius	Price inc. VAT
38-160	5/8"	1/2"	1/16"	£23.13
38-190	3/4"	1/2"	1/8"	£22.92
38-222	7/8"	1/2"	3/16"	£23.71
38-254	1"	1/2"	1/4"	£23.71
38-285	1 1/8"	1/2"	5/16"	£24.50
38-317	1 1/4"	9/16"	3/8"	£27.68



These produce a smooth well proportioned radius on exposed edges



### 1/2" Shank

Part no.	Cut Dia.	Cut ht.	Cut Radius	Price inc. VAT
38-754	1"	1/2"	1/4"	£23.71
38-817	1 1/4"	9/16"	3/8"	£27.68
38-880	1 1/2"	3/4"	1/2"	£31.64
38-945	1 3/4"	7/8"	5/8"	£31.64
38-990	2"	1"	3/4"	£40.37
38-991	2 1/4"	1 1/8"	7/8"	£59.40
38-992	2 1/2"	1 5/16"	1"	£68.93

Brass pilot bits are ideal for sign making & routing in tight corners.

## Brass Pilot, Roundover Bits

### 1/4" Shank

Part no.	Cut Dia.	Cut ht.	Cut Radius	Price inc. VAT
38-001	5/16"	7/16"	1/16"	£19.75
38-002	7/16"	3/8"	1/8"	£21.34
38-003	11/16"	1/2"	1/4"	£22.13
38-004	15/16"	5/8"	3/8"	£23.71

## Multi Radius Bit

### 1/2" Shank

Part no.	Cut Dia.	Cut ht.	Cut Radius	Price inc. VAT
07-500	1 3/4"	7/8"	1/8", 3/16", 3/8"	£34.82

The multi radius bit gives the ability to switch back and forth among three popular radii without changing bits



## Round Nose Bits

### 1/4" Shank

Part no.	Cut Dia.	Cut ht.	Cut Radius	Bearing	Price inc. VAT
14-032	1/8"	3/8"	1/16"		£18.17
14-064	1/4"	1/4"	1/8"		£18.17
14-095	3/8"	1/4"	3/16"		£19.75
14-127	1/2"	3/8"	1/4"		£22.13
14-127B	1/2"	3/8"	1/4"	1/2"	£27.65
14-190	3/4"	7/16"	3/8"		£26.09
14-190B	3/4"	7/16"	3/8"	3/4"	£31.61

### 1/2" Shank

Part no.	Cut Dia.	Cut ht.	Cut Radius	Bearing	Price inc. VAT
14-564	1/4"	5/8"	1/8"		£19.75
14-627	1/2"	1 1/4"	1/4"		£28.48
14-690	3/4"	1 1/4"	3/8"		£32.44
14-690B	3/4"	1 1/4"	3/8"	3/4"	£37.96
14-754	1"	1 1/4"	1/2"		£41.16

Produce a delicate cove

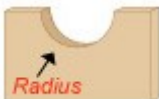

# Edge Forming Bits

## Bull Nose Bits

### 1/4" Shank

Part no.	Cut Dia.	Cut ht.	Bead Ht.	Cut Radius	Price inc. VAT
54-002	7/8"	3/4"	1/4"	1/8"	£25.30
54-004	1 1/8"	1"	1/2"	1/4"	£32.44

### 1/2" Shank

Part no.	Cut Dia.	Cut ht.	Bead Ht.	Cut Radius	Price inc. VAT
54-502	7/8"	3/4"	1/4"	1/8"	£25.30
54-503	1"	7/8"	3/8"	3/16"	£27.68
54-504	1 1/8"	1"	1/2"	1/4"	£32.44
54-507	1 3/8"	1 3/8"	3/4"	3/8"	£39.58
54-509	1 3/4"	1 5/8"	1"	1/2"	£43.55

Make beautiful stair treads, shelves or window sills with this bit.

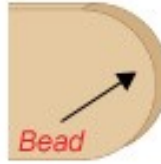

## Edge Beading Bits

### 1/2" Shank

Part no.	Cut Dia.	Cut ht.	Bead dia.	Price inc. VAT
02-500	7/8"	3/8"	1/4"	£27.68
02-502	1"	9/16"	3/8"	£30.06
02-504	1 1/8"	3/4"	1/2"	£31.64



Create a whole range of interesting edge effects & traditional moulding designs

Chamfered edges look deceptively simple but can be difficult if making matching cuts on multisided polygons. These bits make the work a lot easier.

## Chamfer Bits

### 1/4" Shank

Part no.	Cut Dia.	Cut ht.	LOA	Cut Angle	Price inc. VAT
36-190	3/4"	1/2"	2 3/16"	25	£22.13
36-420	1 5/8"	9/16"	2 1/4"	45	£26.89

### 1/2" Shank

Part no.	Cut Dia.	Cut ht.	LOA	Cut Angle	Price inc. VAT
36-920	1 5/8"	9/16"	2 1/4"	45	£26.89
57-504	7/8"	7/8"	2 7/8"	11.25	£28.48
57-503	1"	7/8"	2 7/8"	15	£28.48
57-502	1 1/4"	7/8"	2 13/16"	22.5	£29.27
57-501	1 1/2"	7/8"	2 13/16"		£29.27
<b>Super Duty</b>					
36-950	2 9/16"	1 1/8"	3"	45	£47.51



# Cove & Moulding

## Cove Bits

### 1/4" Shank

Part no.	Cut Dia.	Cut ht.	Cut radius	Price inc. VAT
37-190	7/8"	1/2"	3/16"	£25.30
37-222	1"	1/2"	1/4"	£26.89
37-254	1 1/8"	1/2"	5/16"	£26.89
37-286	1 1/4"	1/2"	3/8"	£27.68
37-350	1 1/2"	5/8"	1/2"	£28.48

A simple shape that lends an elegant detail to almost any edge. Furniture, moulding & cabinet doors go from ordinary to elegant with a cove.

### 1/2" Shank

Part no.	Cut Dia.	Cut ht.	Cut radius	Price inc. VAT
37-690	7/8"	1/2"	3/16"	£25.30
37-722	1"	1/2"	1/4"	£26.89
37-786	1 1/4"	1/2"	3/8"	£27.68
37-850	1 1/2"	5/8"	1/2"	£28.48
37-950	1 3/4"	3/4"	5/8"	£34.02
37-951	2"	7/8"	3/4"	£41.16

## Table Edge Bit

### 1/2" Shank

Part no.	Large dia.	Cut ht.	LOA	Price inc. VAT
56-601	2 1/2"	3/4"	2 1/4"	£61.00

## Large Profile Moulding Bits

### 1/2" Shank

Part no.	Large dia.	Cut ht.	LOA	Price inc. VAT
55-901	15/16"	1 3/8"	3 1/4"	£51.47
55-902	1 1/16"	1 5/8"	3 1/4"	£56.23
56-501	1 3/4"	1 1/8"	3"	£51.47
56-802	2 13/16"	1 7/8"	3 3/4"	£72.10

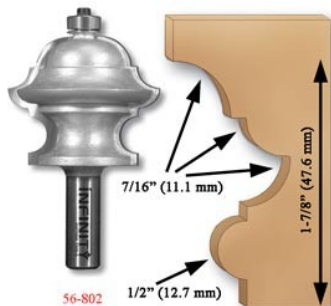
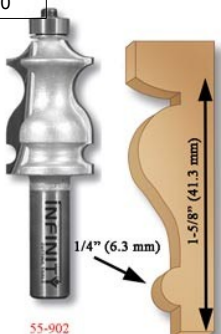
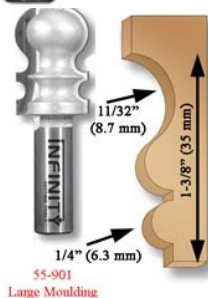
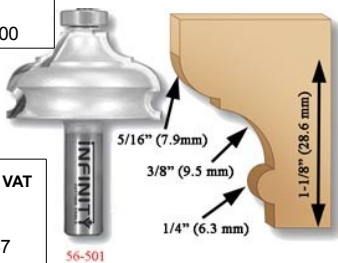

www.InfinityTools.co.uk  
0560 115 0224

# Architectural Bits

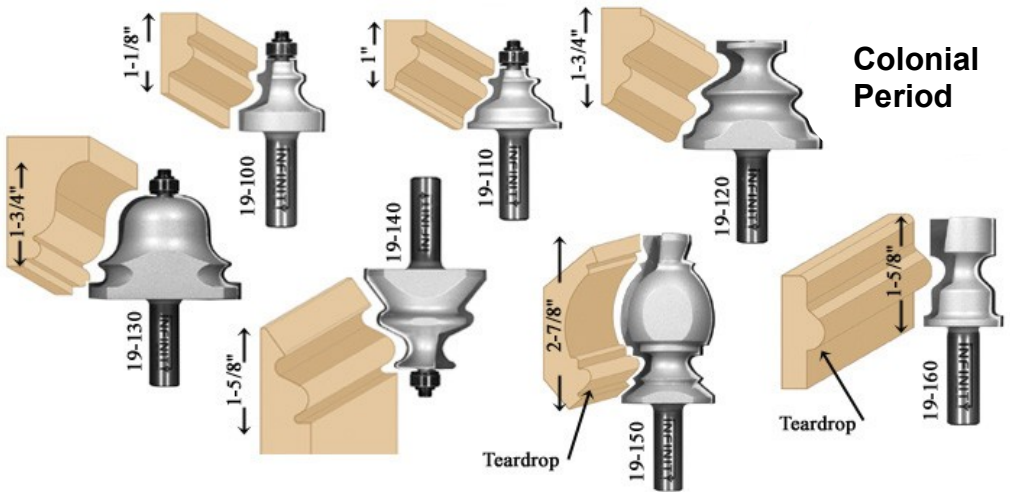

**Colonial Period**

## Colonial Period Set 1/2" Shank

Part no.	Cut Dia.	Cut ht.	LOA	Price inc. VAT
19-100	1 3/8"	1 1/8"	2 1/4"	£38.78
19-110	1 5/8"	1"	2 1/2"	£38.78
19-120	2 1/4"	1 3/4"	3 1/4"	£64.96
19-130	2 1/2"	1 3/4"	3 1/4"	£69.72
19-140	2"	1 5/8"	3 1/8"	£59.40
19-150	1 5/8"	2 7/8"	4 3/8"	£74.47
19-160	1 1/8"	1 5/8"	3 1/8"	£46.72

## 17<sup>th</sup> Century Period bits 1/2" Shank

	Part no.	Cut Dia.	Cut ht.	LOA	Price inc. VAT
<b>A</b>	17-505	2 5/8"	7/8"	2 3/4"	£61.79
<b>B</b>	17-510	1 1/16"	1 1/8"	2 9/16"	£41.16
<b>C</b>	17-515	1 1/4"	1 1/16"	1 9/16"	£34.02
<b>D</b>	17-520	1"	1/2"	2"	£30.85
<b>E</b>	17-525	1 1/8"	5/8"	2 1/8"	£30.85
<b>F</b>	17-530	2 1/8"	1 1/8"	2 5/8"	£58.61
<b>G</b>	17-535	1 7/16"	1 1/8"	2 5/8"	£41.16
<b>H</b>	17-540	1 1/4"	3/4"	2 3/8"	£36.41
<b>I</b>	17-545	1 3/16"	3/4"	2 1/4"	£36.41
<b>J</b>	17-550	2 1/4"	1 5/16"	3 1/4"	£61.79
<b>K</b>	17-555	2 7/8"	1 1/8"	3 1/8"	£61.79

## 17<sup>th</sup> Century

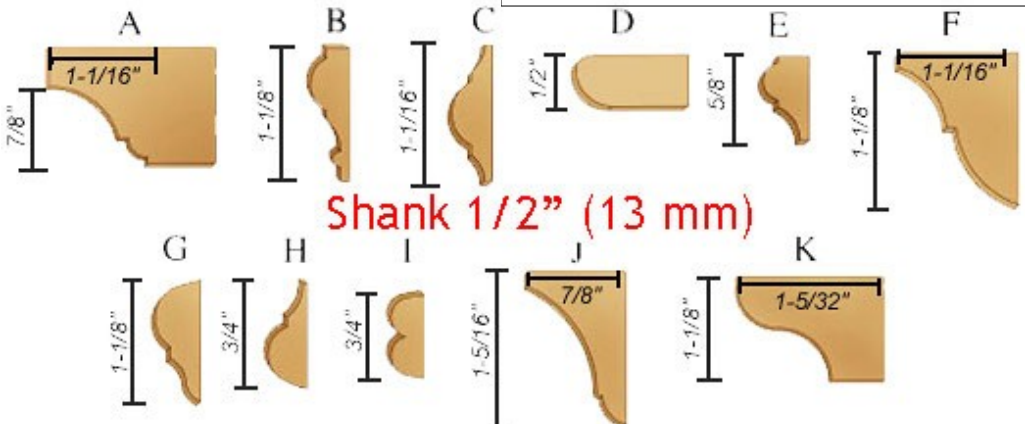

**Shank 1/2" (13 mm)**

## •Router Safety Tips:

- **Wear Eye and Ear Protection**
- **Don't force the bit or the router.**
- **Be sure that at least 3/4 of the shank length is inserted into the router collet.**
- **Don't "bottom out" the bit in the collet. The shank should be about 1/8" from the collet bottom.**
- **Minimise bit deflection by using template guide collars whenever possible. Collars absorb much of the lateral force that might deflect the bit.**
- **Reduce router speeds for large bits.**
- **Use a router table & fence whenever possible.**
- **Adjust your fence so there is a slight clearance between the guide bearing and the stock.**
- **Remove large amounts of stock in 2 or more passes. (generally when the cross section of the stock to be removed is greater than a 3/8" square)**
- **Don't use dull or damaged bits.**
- **Large diameter bits should be used in a router table.**
- **The speed at which your bit rotates affects both the safety and quality of your work. Larger bits require slower router speeds. Many routers now have speed controls built-in. If your router doesn't give you a choice of speeds, consider buying a router speed control.**

Bit Diameter	Max. Speed
1"	24,000 RPM
1-1/4" to 2"	18,000 RPM

Bit Diameter	Max. Speed
2-1/4" to 2-1/2"	16,000 RPM
3" to 3-1/2"	12,000 RPM

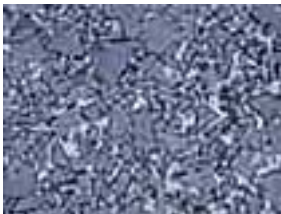

Other carbide (x1500)

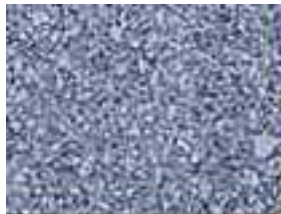

Infinity carbide (x1500)

Infinity Tools specifies only micrograin carbide for its bits and cutters. Note the density of the Infinity sample compared to coarse grained carbide above.

# Rebate Combination Set 00-556

**Price: £67.26**

This combination set is more than just another rebating kit. Featuring aggressive shear angles for ultra-smooth cuts and made from premium quality materials, these unique sets cut just about any rebate you will need and they will flush trim too!

7 bearings for making different size rebates. The outside diameter of the bearings are:

3/8" (9.5mm),  
1/2" (12.7 mm),  
5/8" (15.9 mm),  
3/4" (19 mm),  
7/8" (22.2 mm),  
1-1/8" (28.6mm),  
1-3/8" (34.9 mm).

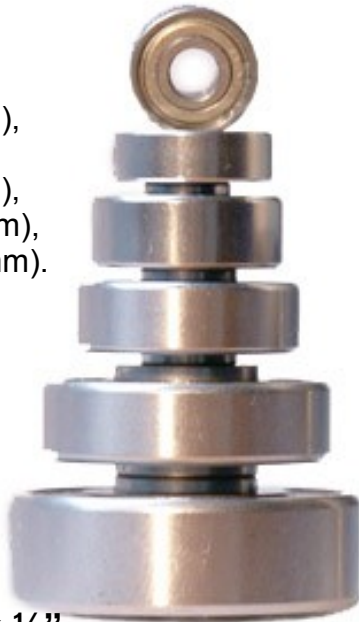

**Shank 1/2"**

**Cutter Diameter 1-3/8 inch (34.9 mm)**

**Cutter Height 1 inch (25.4 mm)**

**Overall length 1-7/8 (73 mm)**

## Postage & Packing

**UK**

Up to £40 - £3.90  
£41 to £100 - £5.00  
Over £100 - FREE

**Other EU countries**

Up to £50 - £9.00  
£50 to £100 - £11.00  
£100 to £110 - £13.00  
£110 to £135 - £18.00  
Over £135 - FREE